

For professional use only. Please refer to the conditions of use of our catalogue.

March 2002

## 4VRE15 200A code P04-10

Voltage	Frequency	Input power	Current	Capacitor	Air flow	Rotational speed	Sound level	Direction of rotation	Max. Air temp.
V	Hz	Wa	A	μF	m <sup>3</sup> /h	rpm	dBA	↻	°C
230	50	31	0,14	1,5	500	1410	50	R	-20 / +50
230	60	31	0,14	1,5	535	1680	54	R	-20 / +50

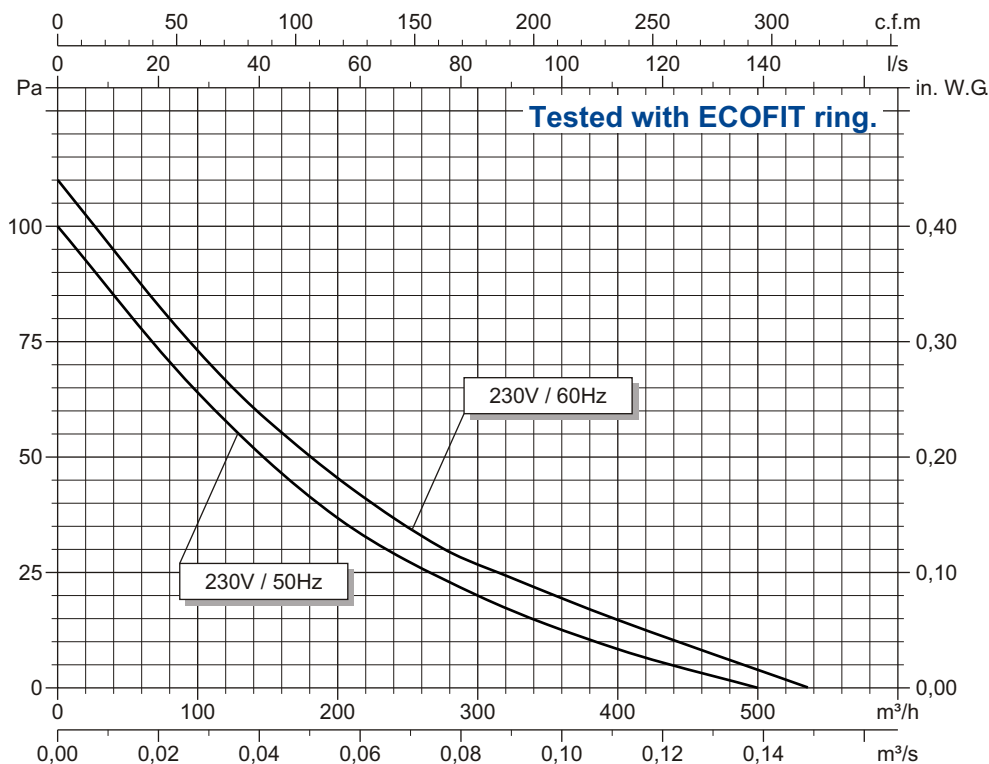
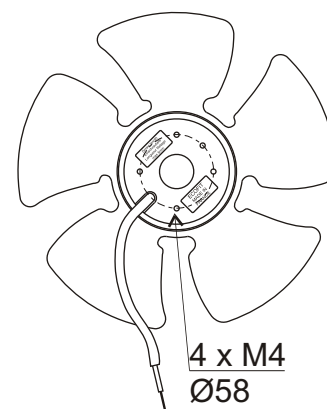
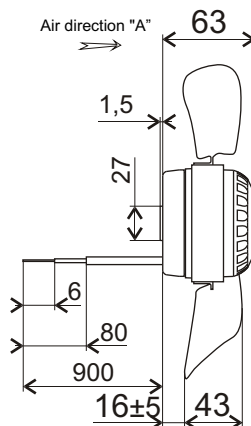
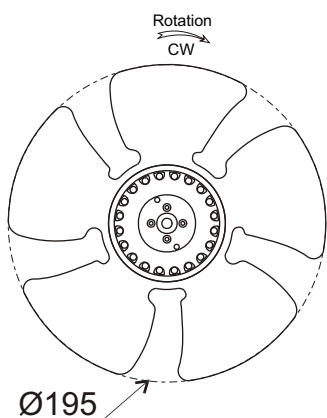
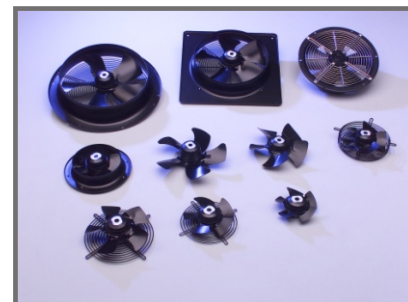

- Ball bearings.
- C.I.F windings protected by thermal cut-out.
- Protection IP 44.
- Balancing G6.3.
- Zinc coated impeller.
- Rotor and impeller painted black.

Capacitor for 50Hz	Capacitor for 60Hz	Connecting box	Connector
19005-0	19005-0	39658	09145-0

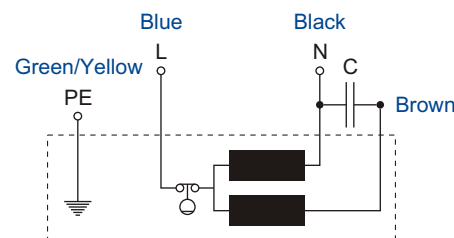

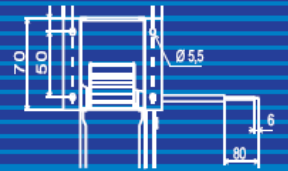

For professional use only. Please refer to the conditions of use of our catalogue.



## Axial fan

200

